

# UPPFINNAREN

**Hur många ord kommer du på?**

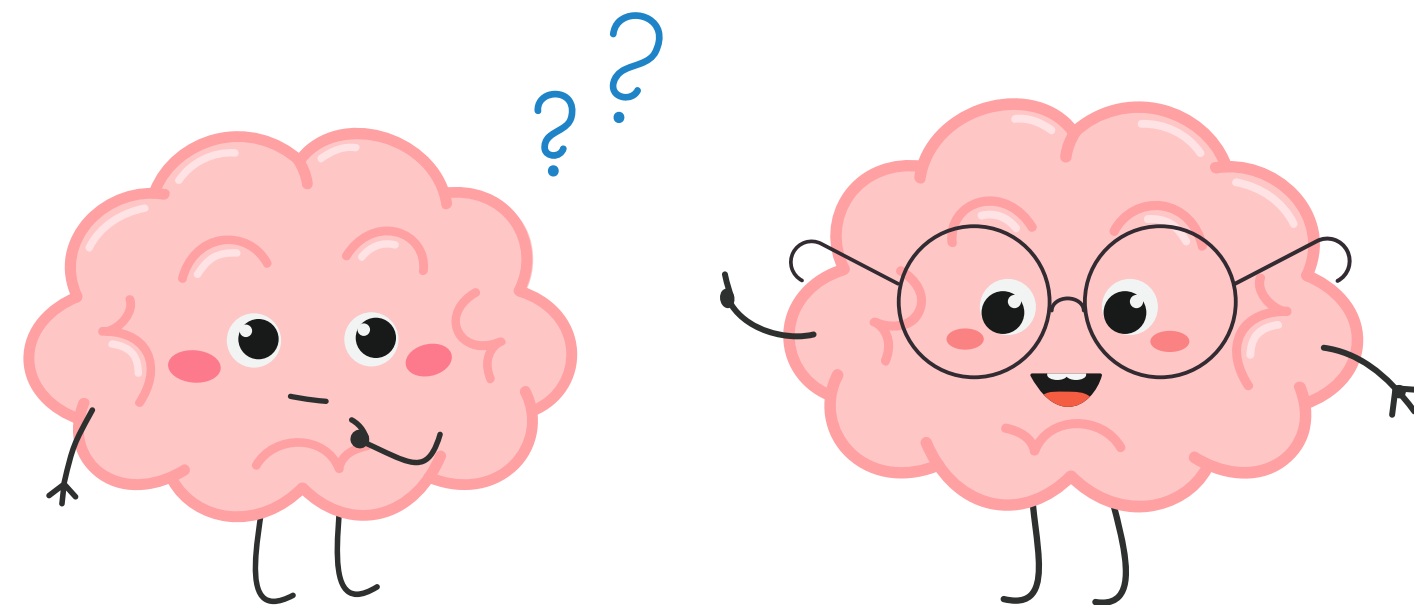

I den här övningen ska eleverna tillsammans med ett par eller i en grupp komma på så många svenskspråkiga ord som möjligt utav de bokstäver de ser.

Man kan välja mellan två olika alternativ, beroende på gruppens nivå:

1. Visa bara bokstäverna
2. Visa bokstäverna med hjälpbilder

## Så här spelar du:

1. Bilda par eller grupper på 3 personer. Man kan också spela ensamt.
2. Kom på ett svenskspråkigt namn till ert lag! (Valfri)
3. Läs igenom spelreglerna för eleverna:
  - a. Läraren visar en rad bokstäver.
  - b. Försök komma på så många ord som möjligt utav bokstaverna som du ser. Orden behöver inte innehålla alla bokstäver.
  - c. Av varje ord ni kommit på får ni ett poäng. Den som samlar mest poäng vinner!

*Tips! I oklara fall kan man kolla upp ordet på [www.svenska.se](http://www.svenska.se).*

**Börja spela!**

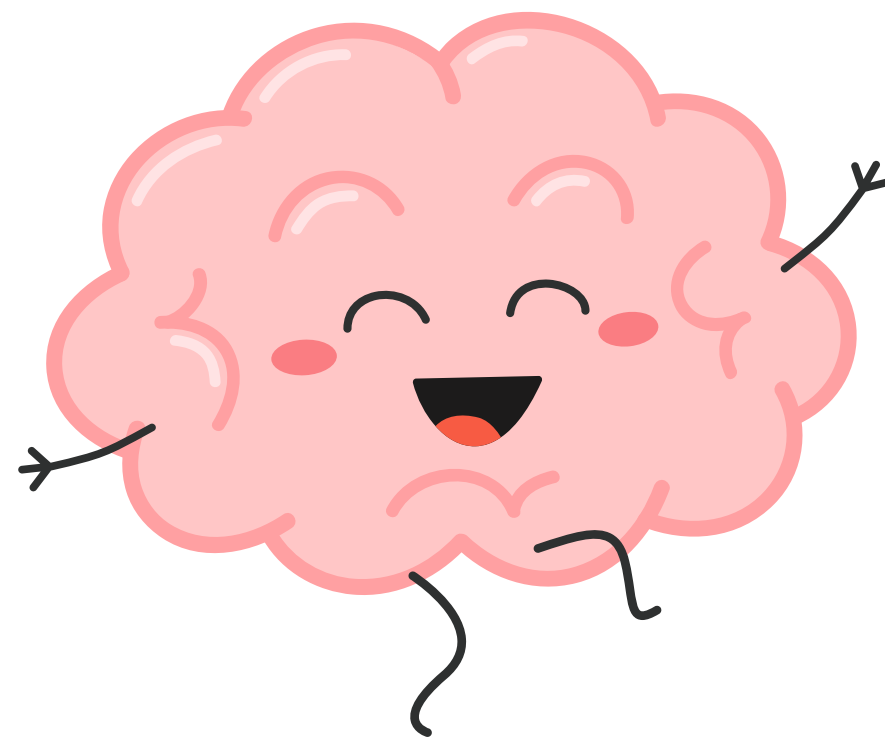

!

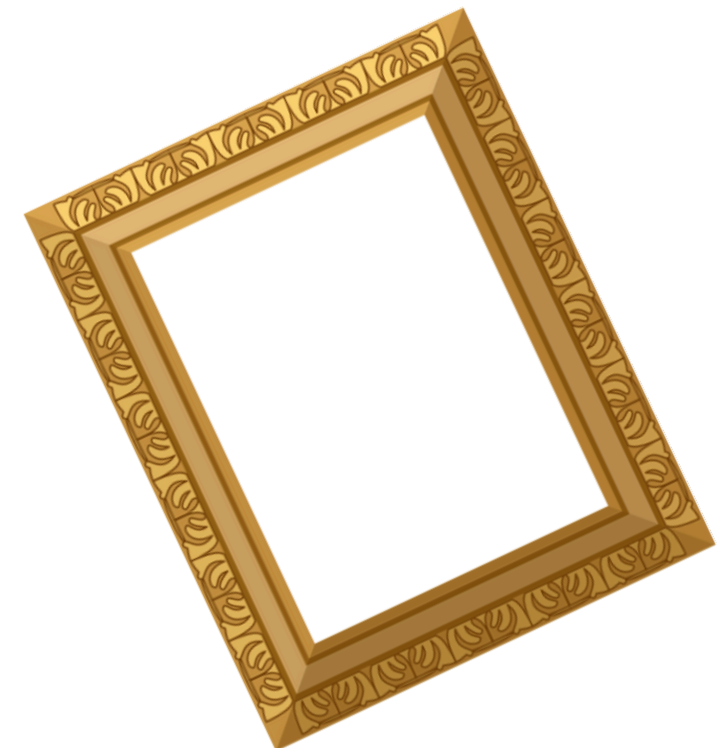
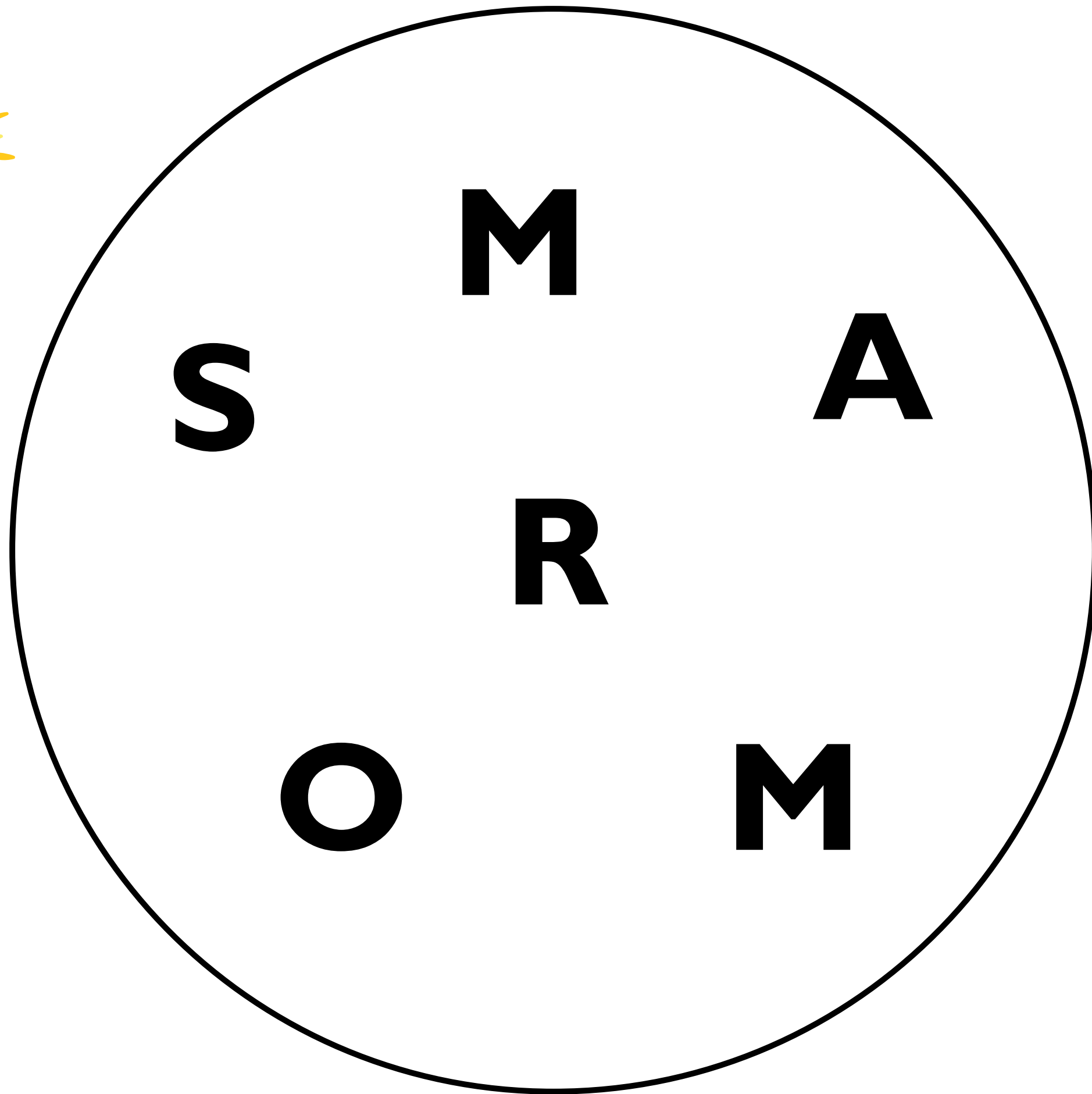
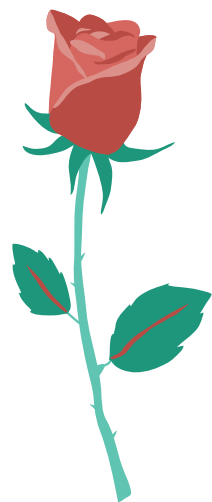
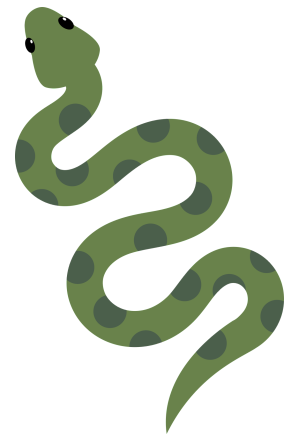
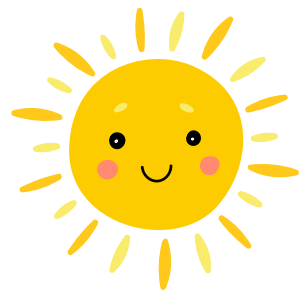

2.

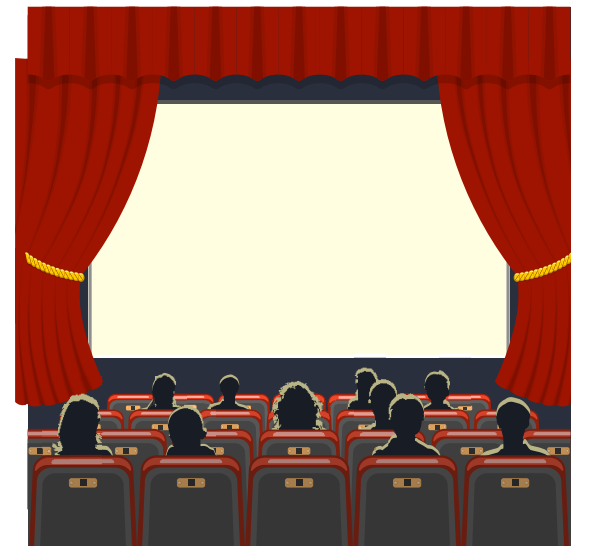
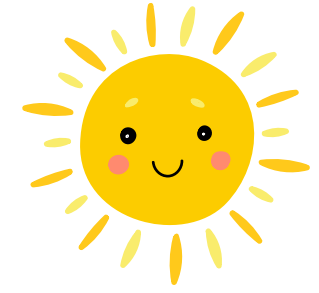
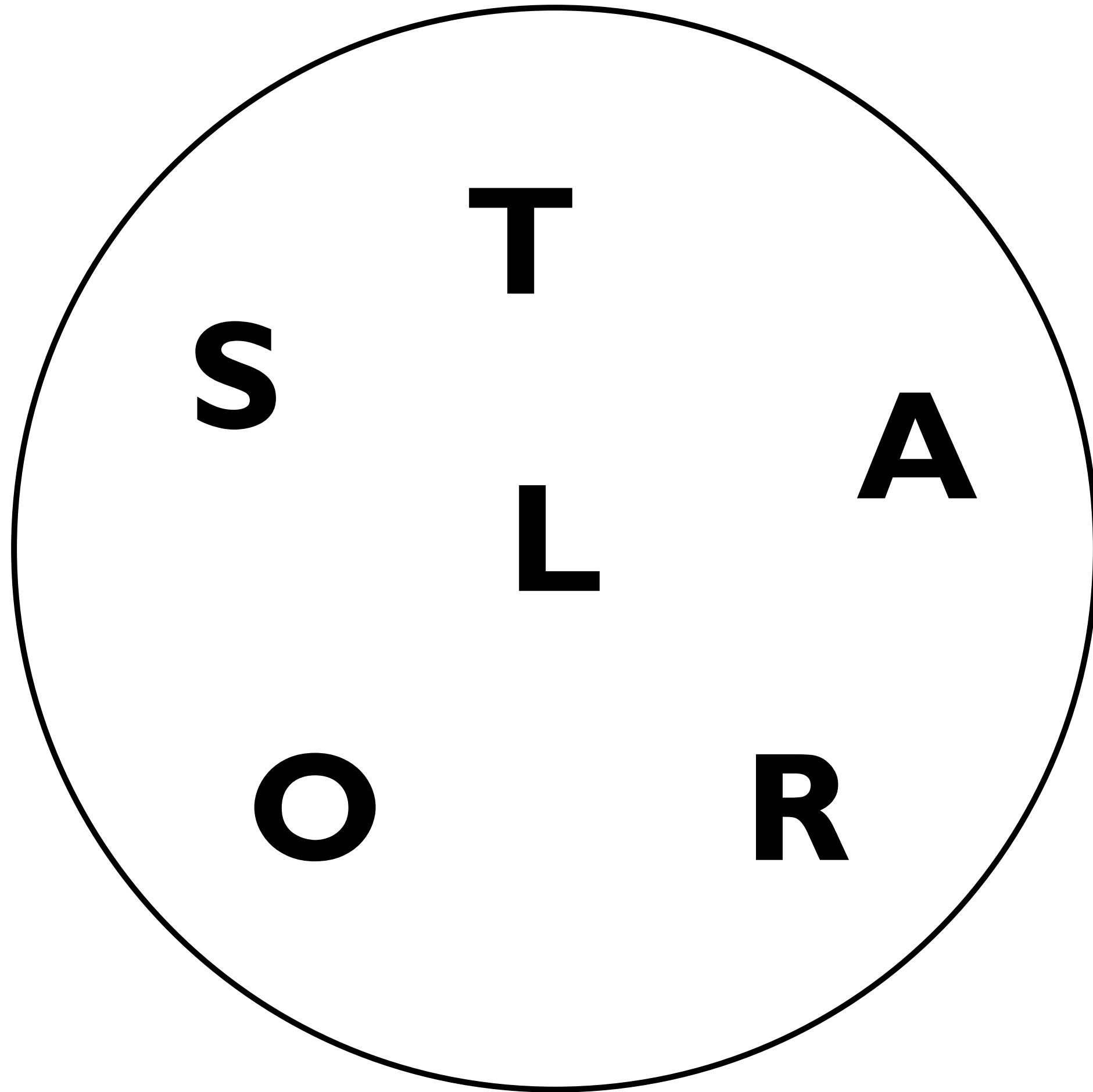

3.

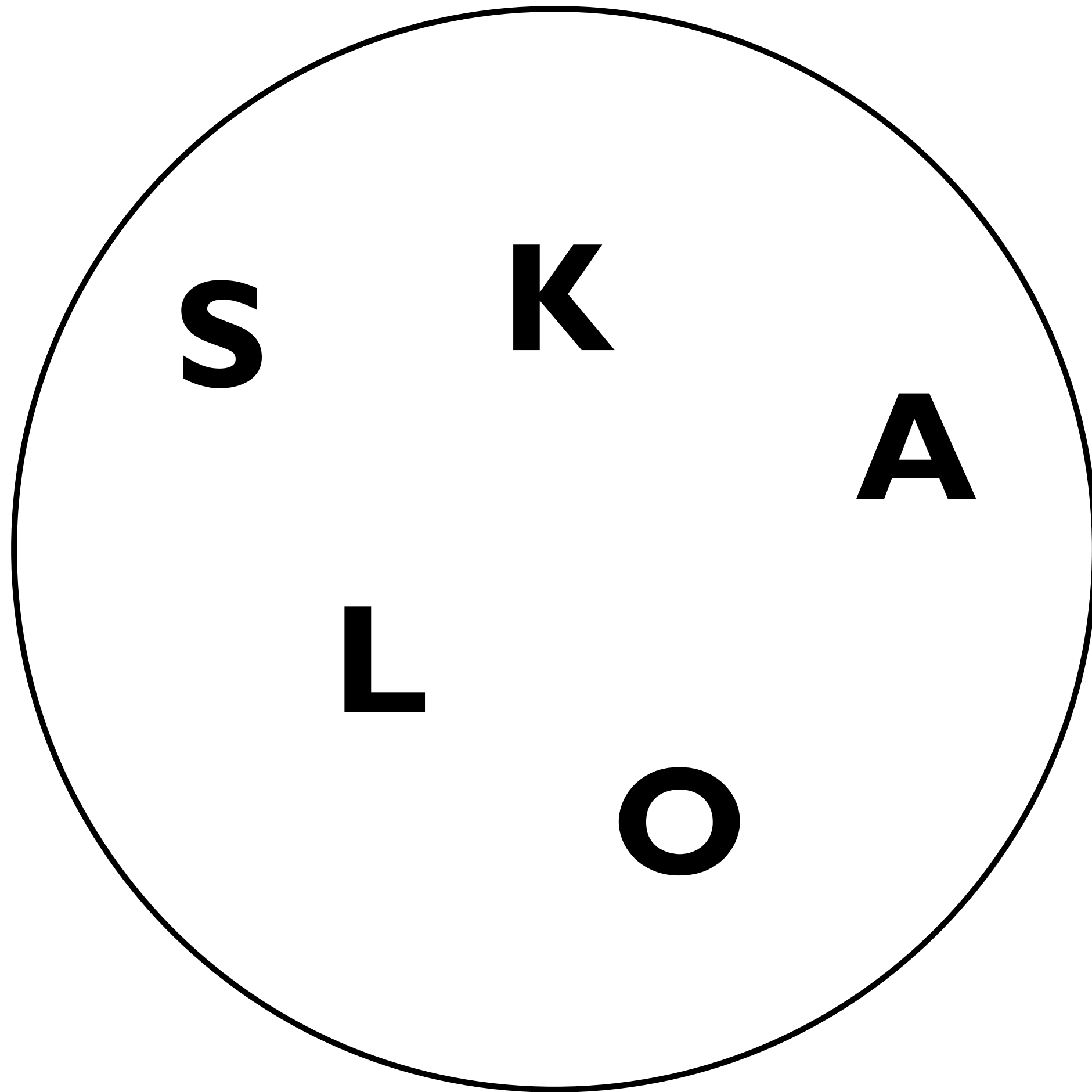
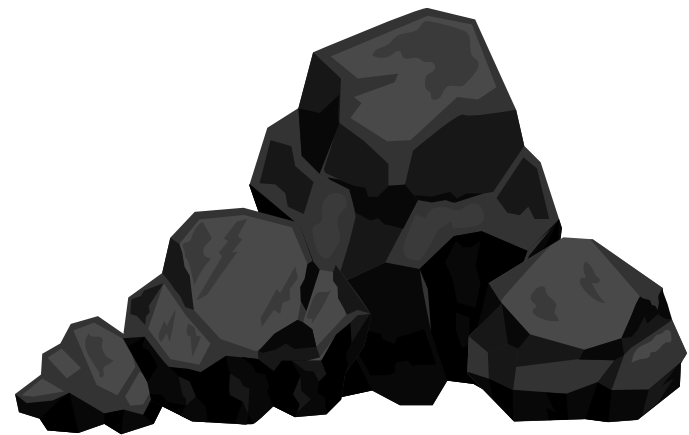

4.

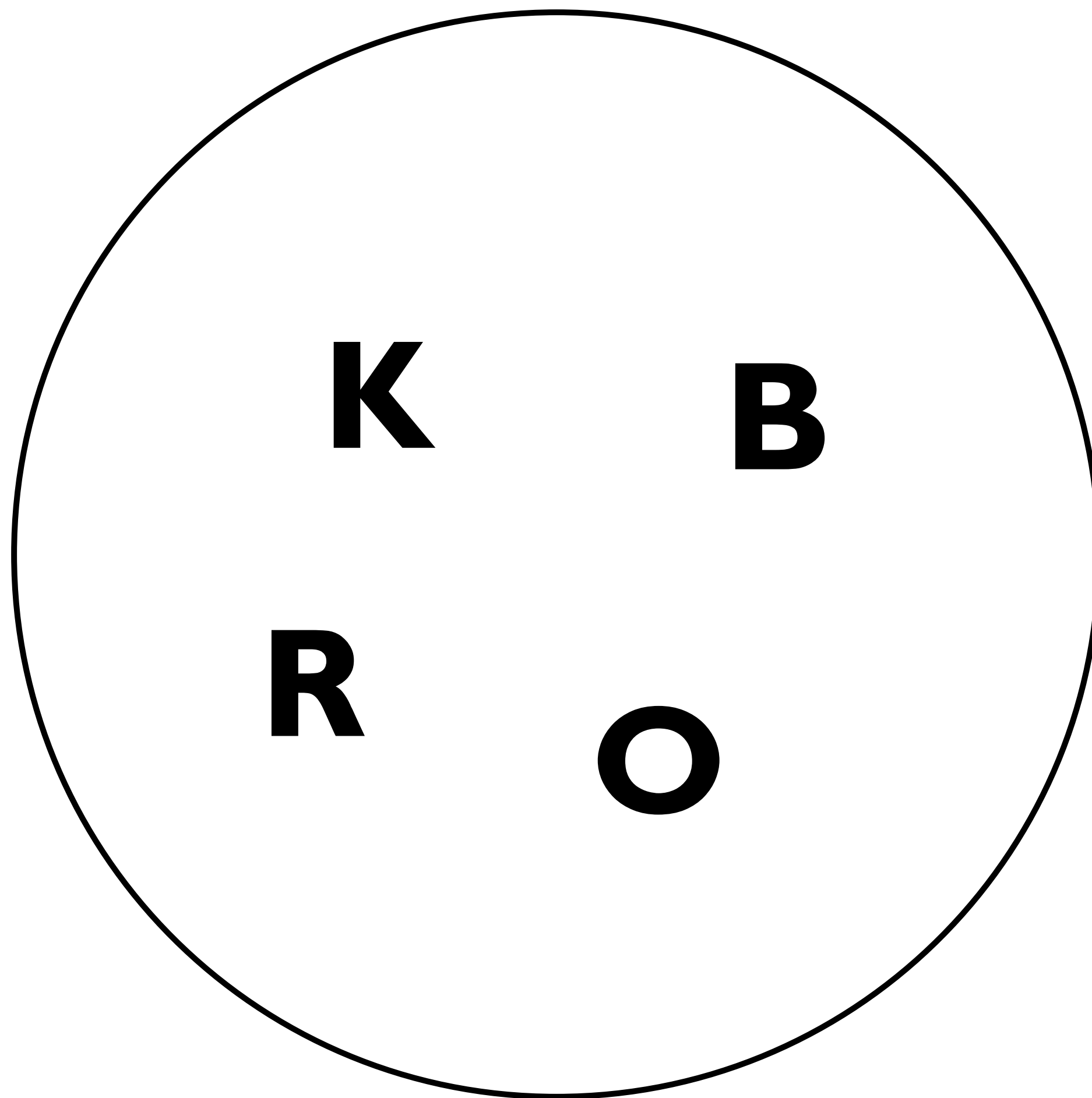
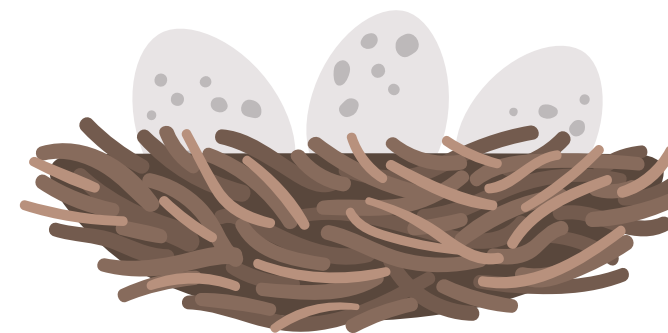
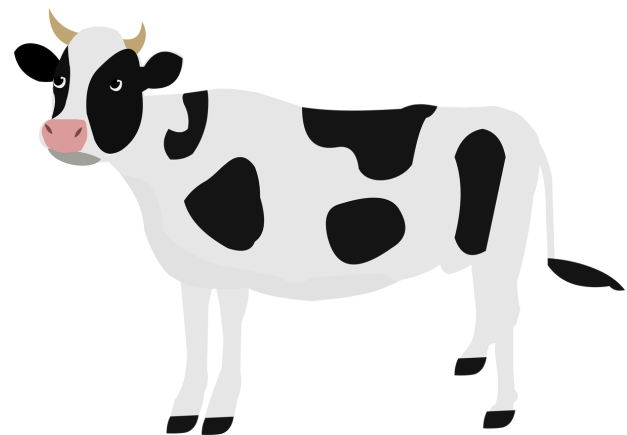



5.

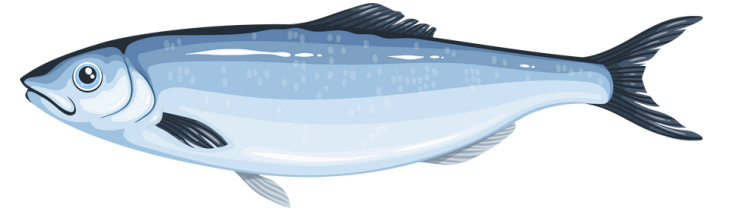
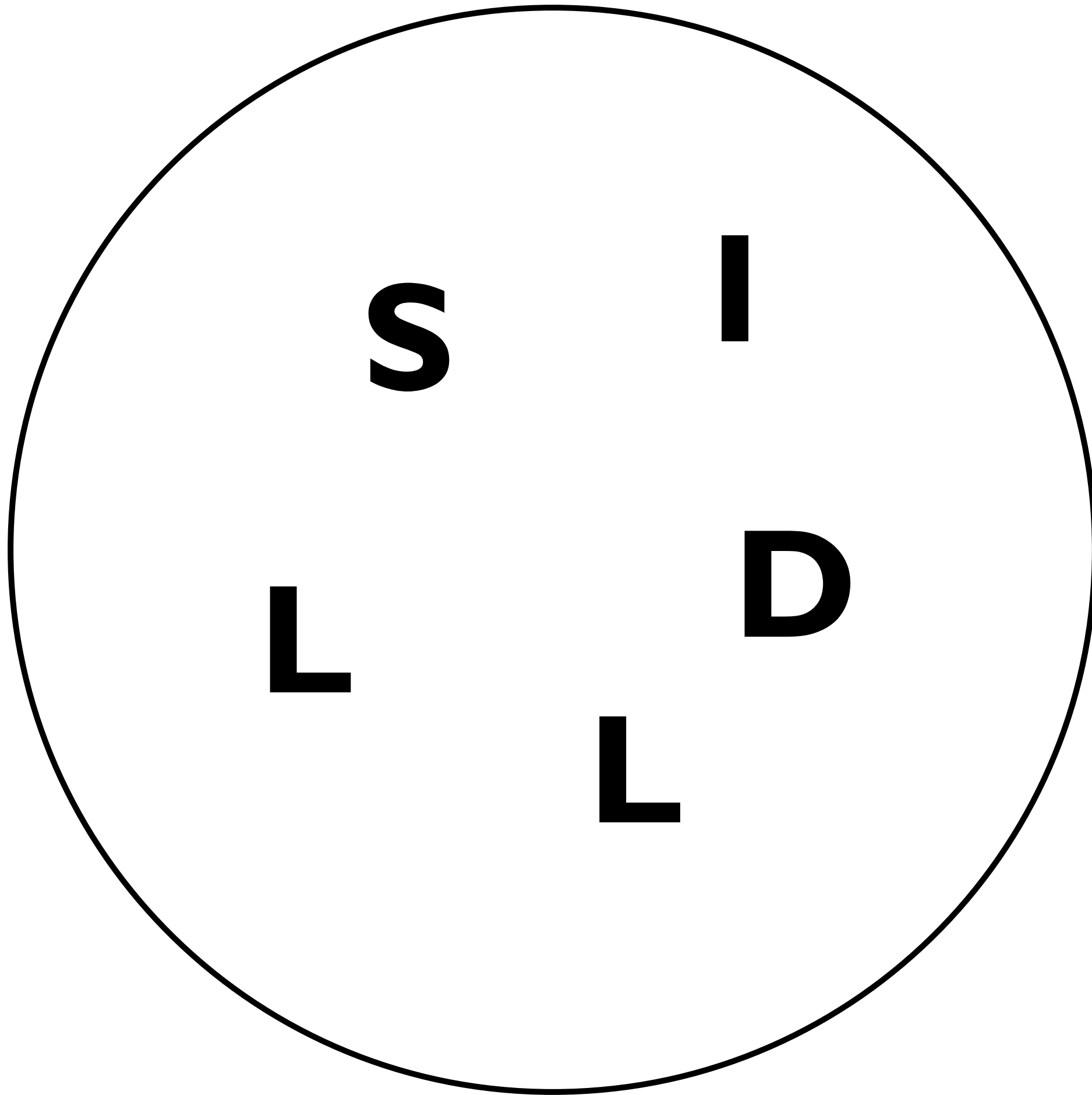
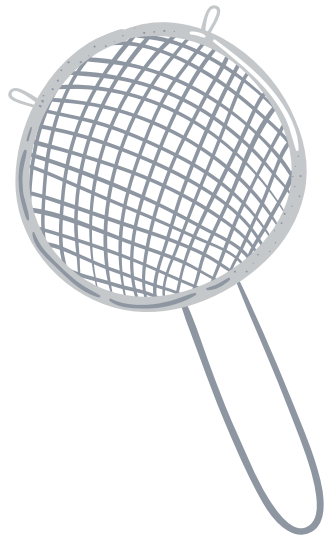
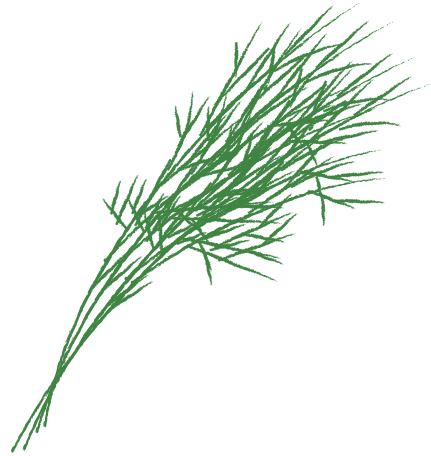

6.

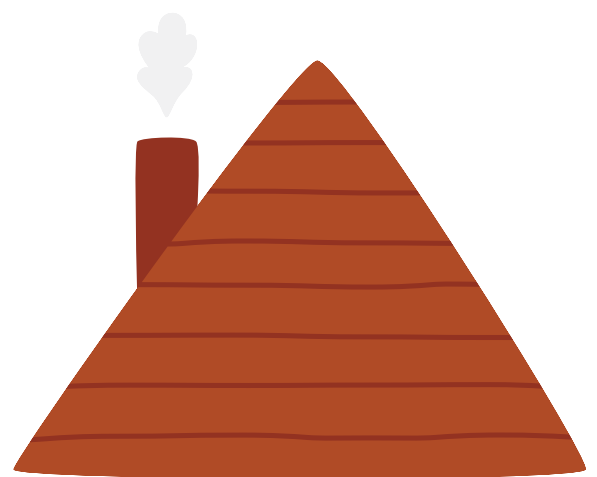
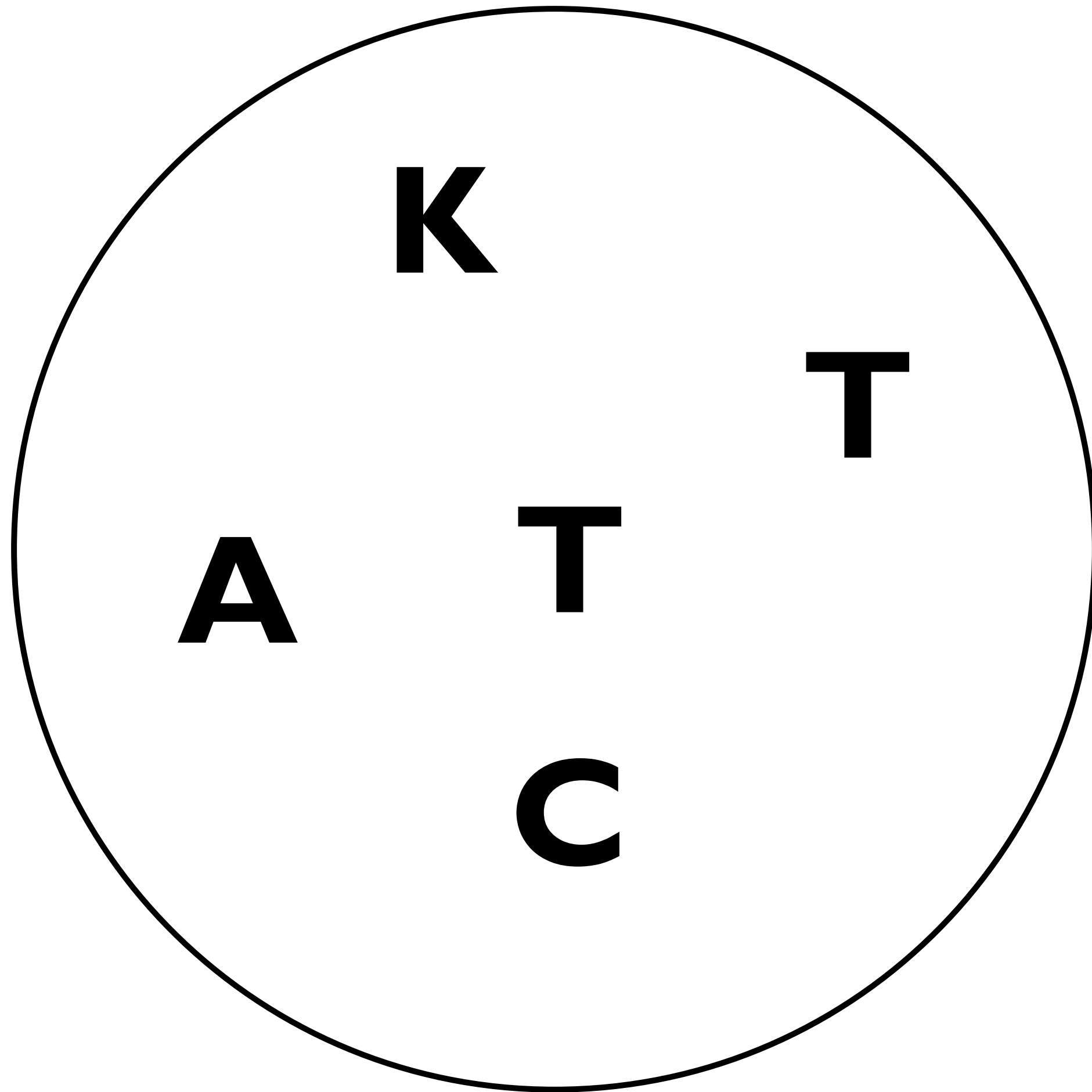

7.

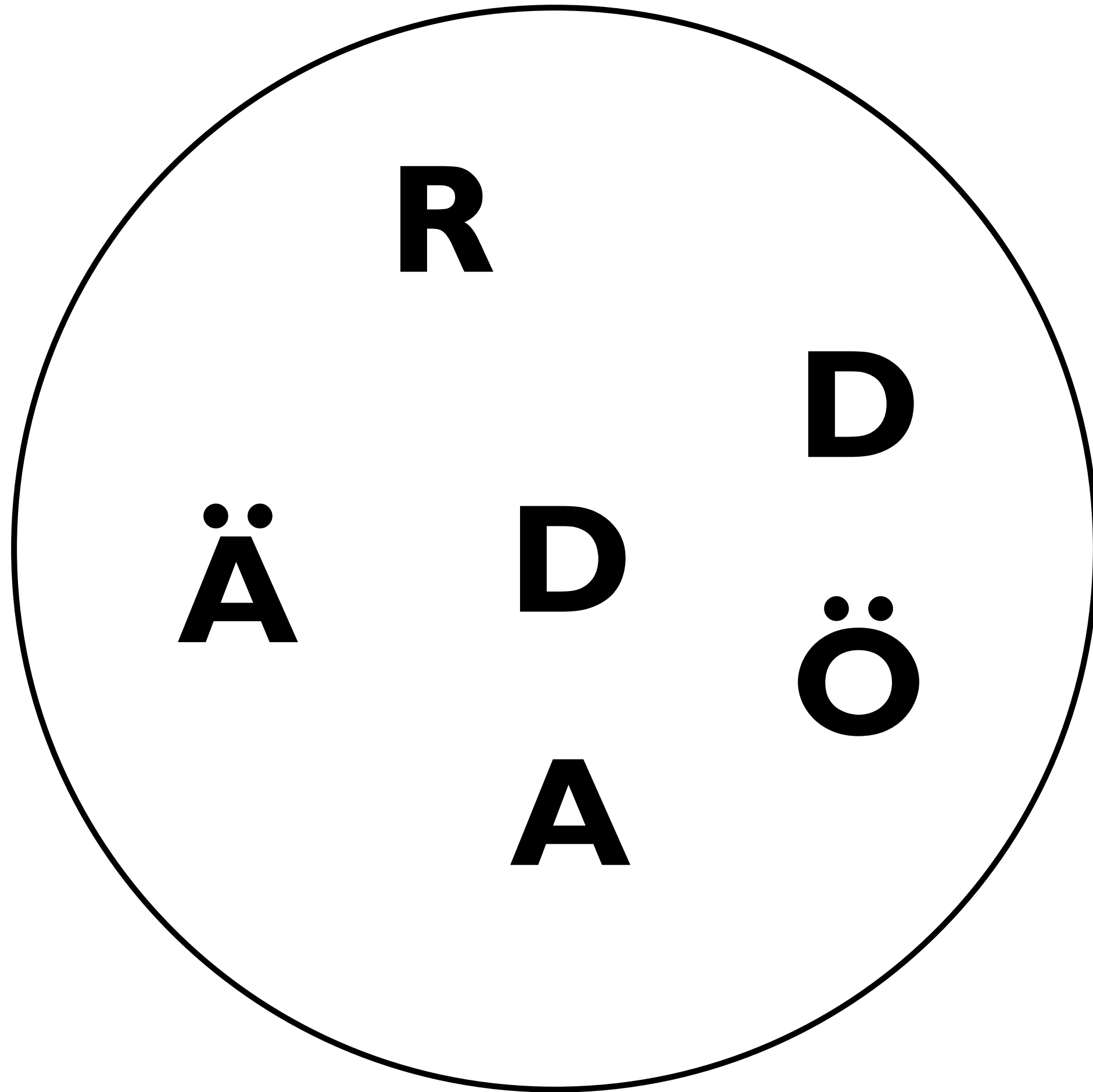
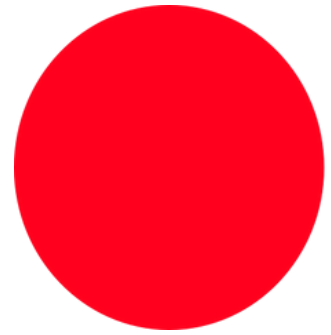

8.

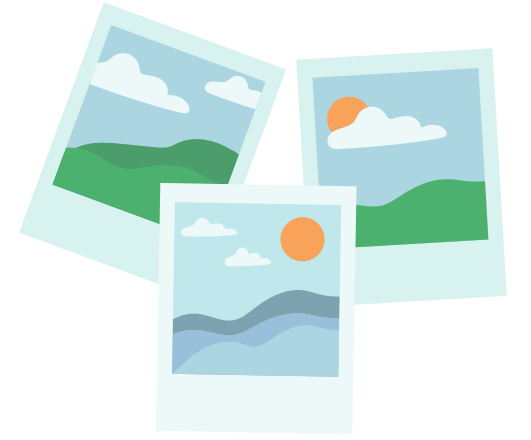
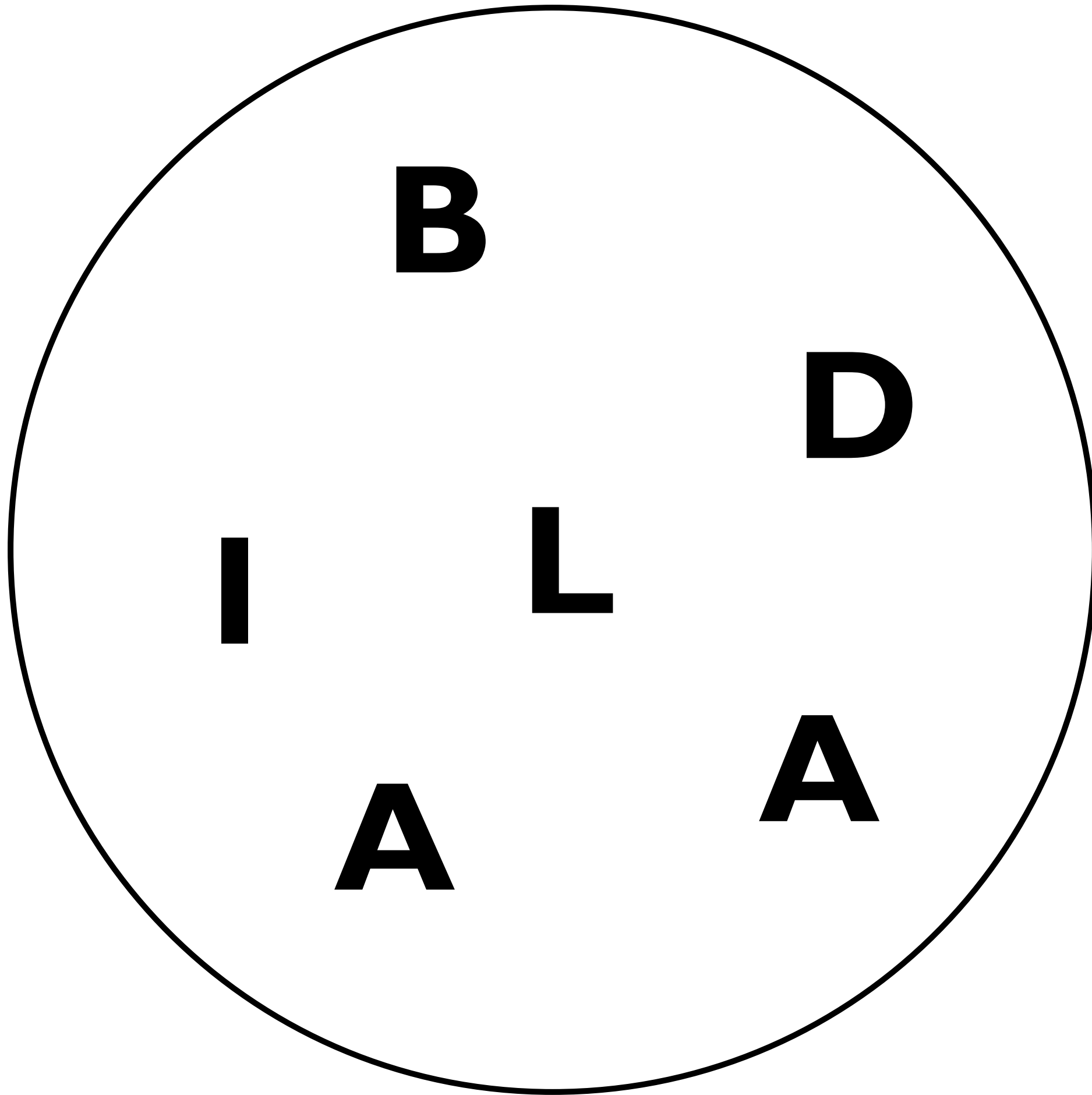

9.

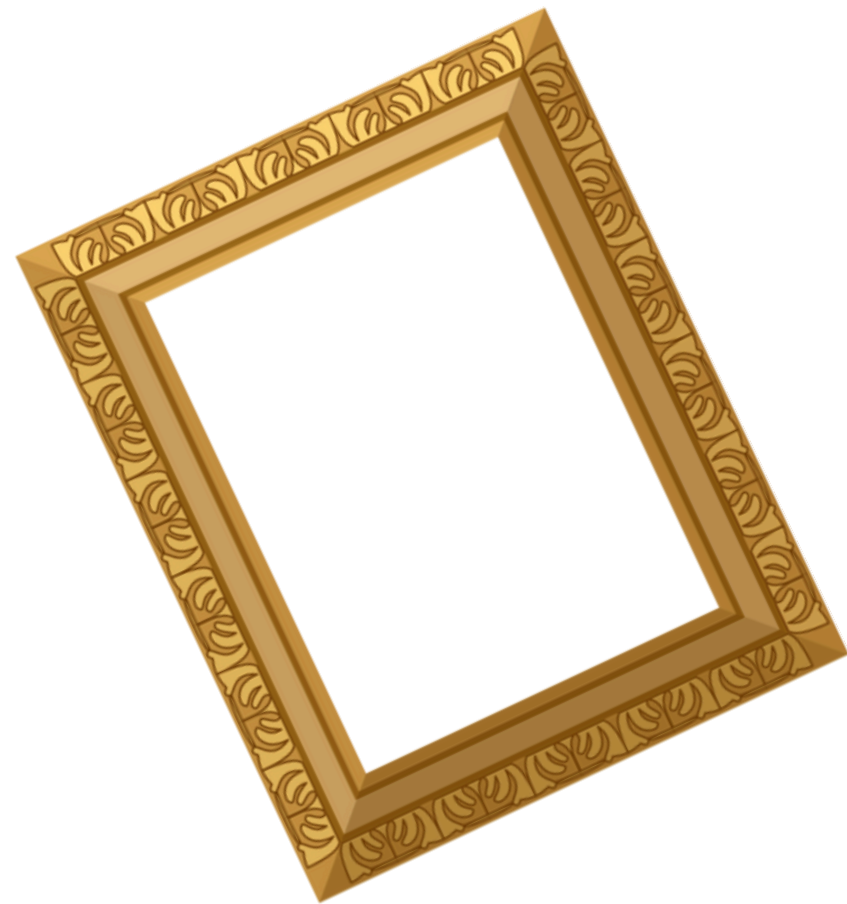
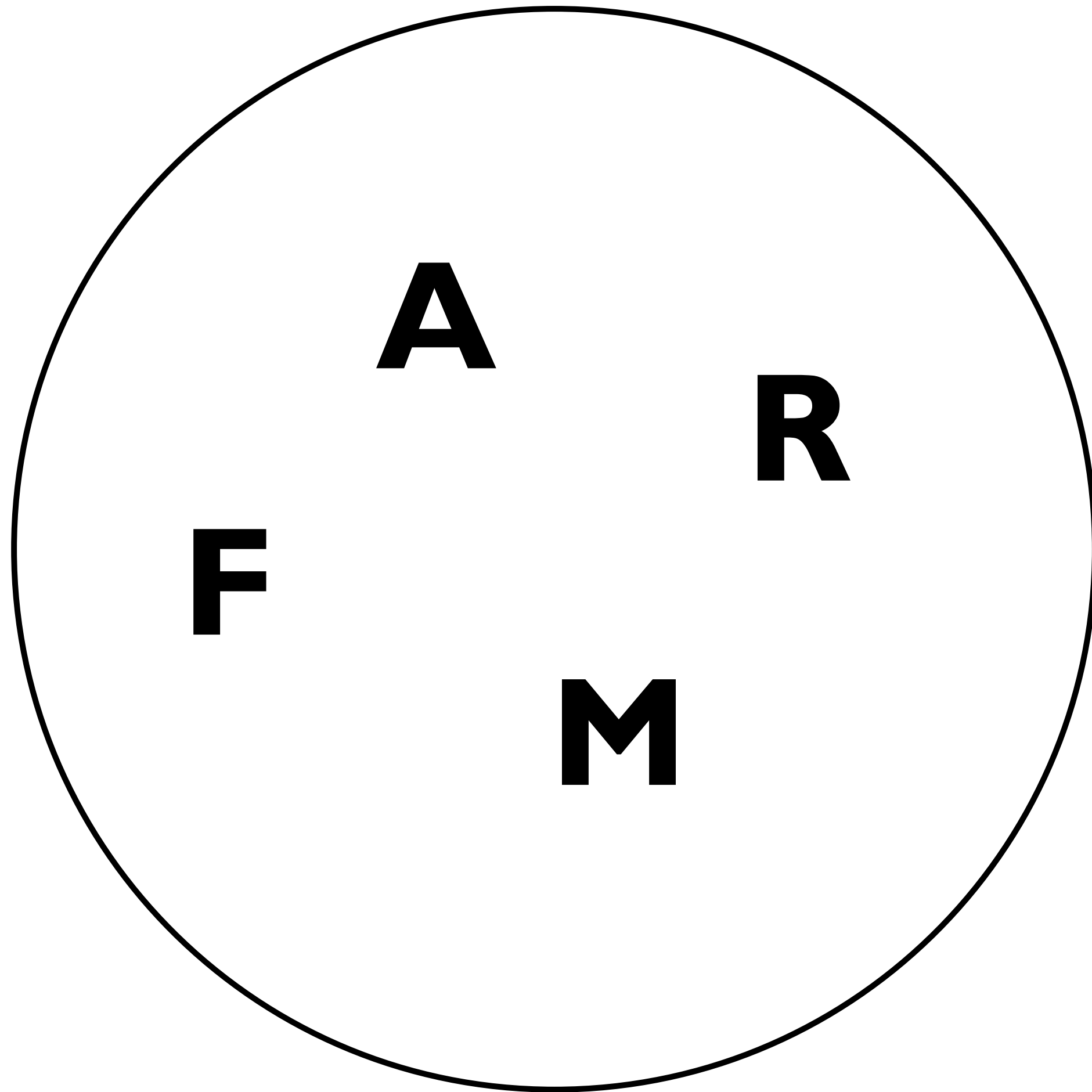

10.

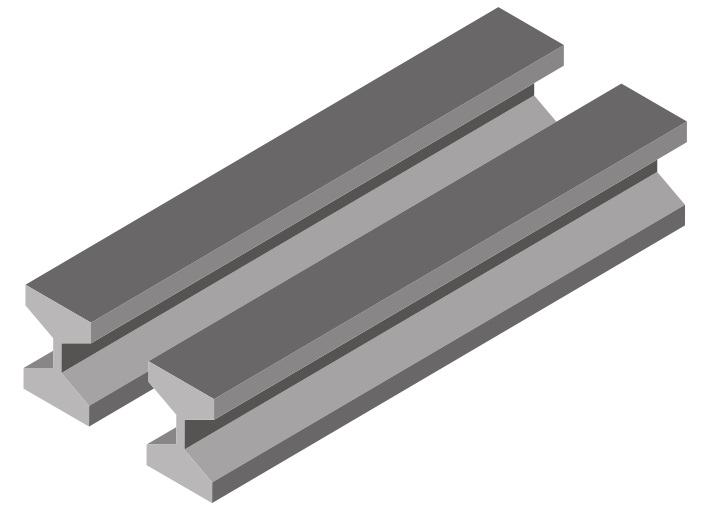
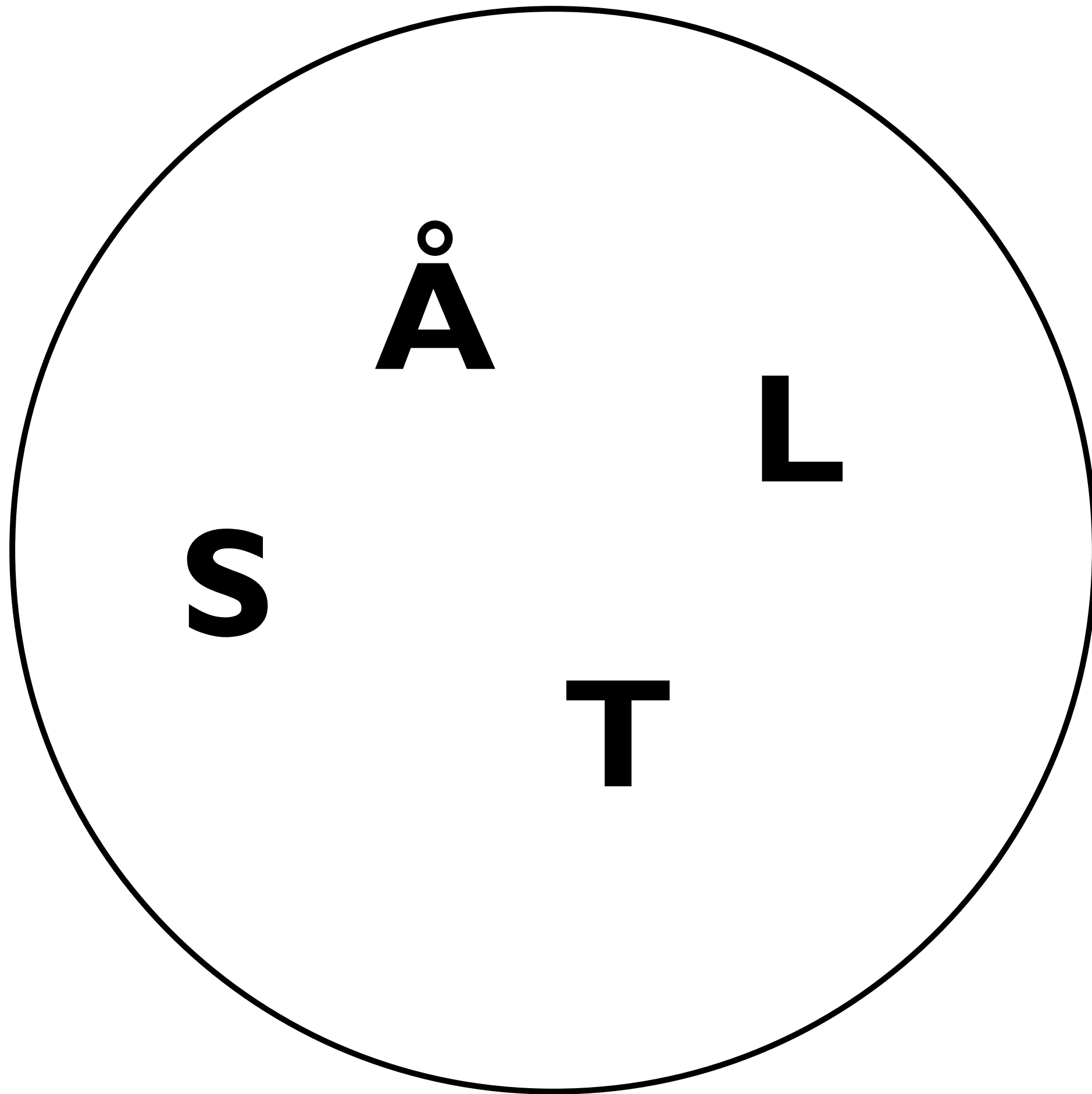
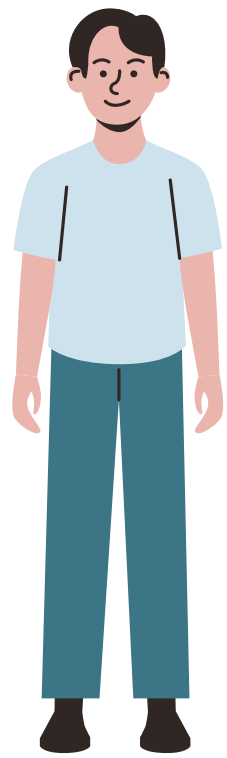

## Svar:

1. ROS, SOMMAR, MARS, ORM, RAM
2. STOLAR, STOL, SOL, SAL, LORT, (LARS)
3. SOL, SAK, SKO, KOL
4. KO, KOR, BOK, BO, BOR, ORK
5. SILL, DILL, STIL, SIL, TILL, SLIT
6. KATT, TAK, TACK, TAKT, AKT
7. RÄDDA, RÄDD, ÄRAD, RAD, DRA, ÄRAD, RÖD, DÖ, DÖR
8. BILDA, BILD, BIL, BLAD, BAD, BADA, DAL, BAL, LIDA, LADA
9. FAR, FAR, ARM, FRAM, FARM
10. STÅL, LÅT, STÅ, LÅS, SLÅ

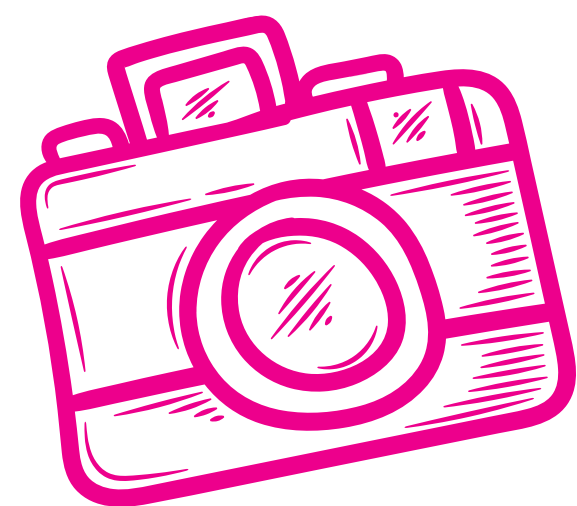

**Fint jobbat!**





